

All 100

ME01

CHASSIS ALUMINIUM OSCILLO
POSE AU NU INTERIEUR
+ BAVETTE ALUMINIUM

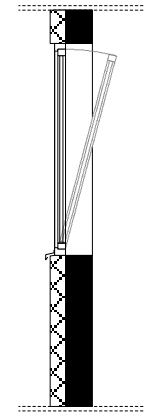
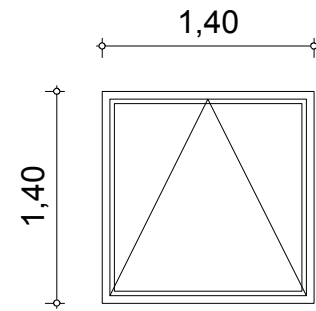

All 100

ME01'

CHASSIS ALUMINIUM OSCILLO
POSE AU NU EXTERIEUR
+ BAVETTE ALUMINIUM

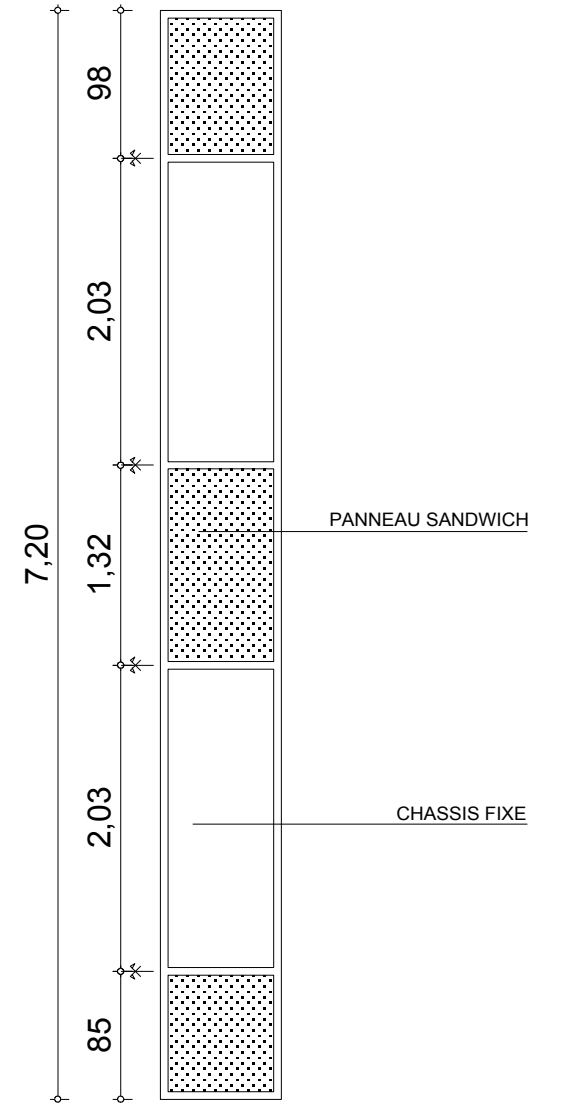

ME02

ENSEMBLE MENUISÉ
POSE AU NU EXTERIEUR DE LA FACADE

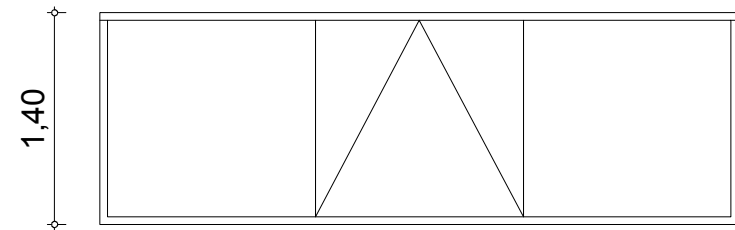
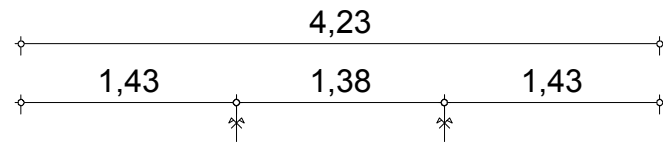

All 100

ME08

CHASSIS ALUMINIUM OSCILLO
POSE AU NU INTERIEUR
+ BAVETTE ALUMINIUM

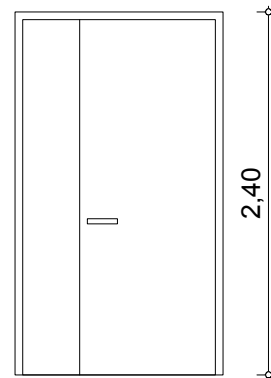
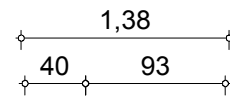

PE01

PORTE TIERCE
METALLIQUE TOLEE

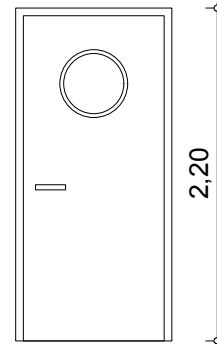
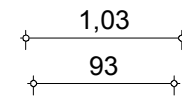

PE02

PORTE
METALLIQUE TOLEE
+
HUBLOT VITRÉ

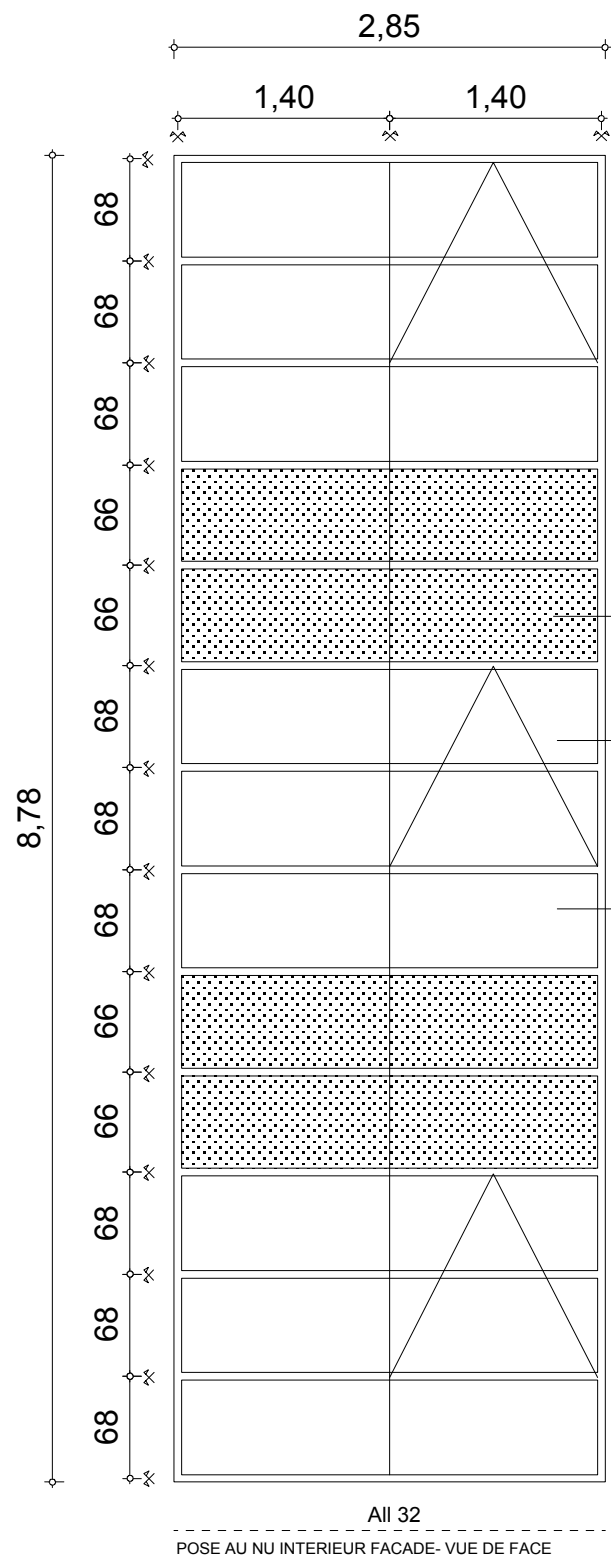

ME03
ENSEMBLE MENUISÉ
AVEC OUVRANTS CACHÉS

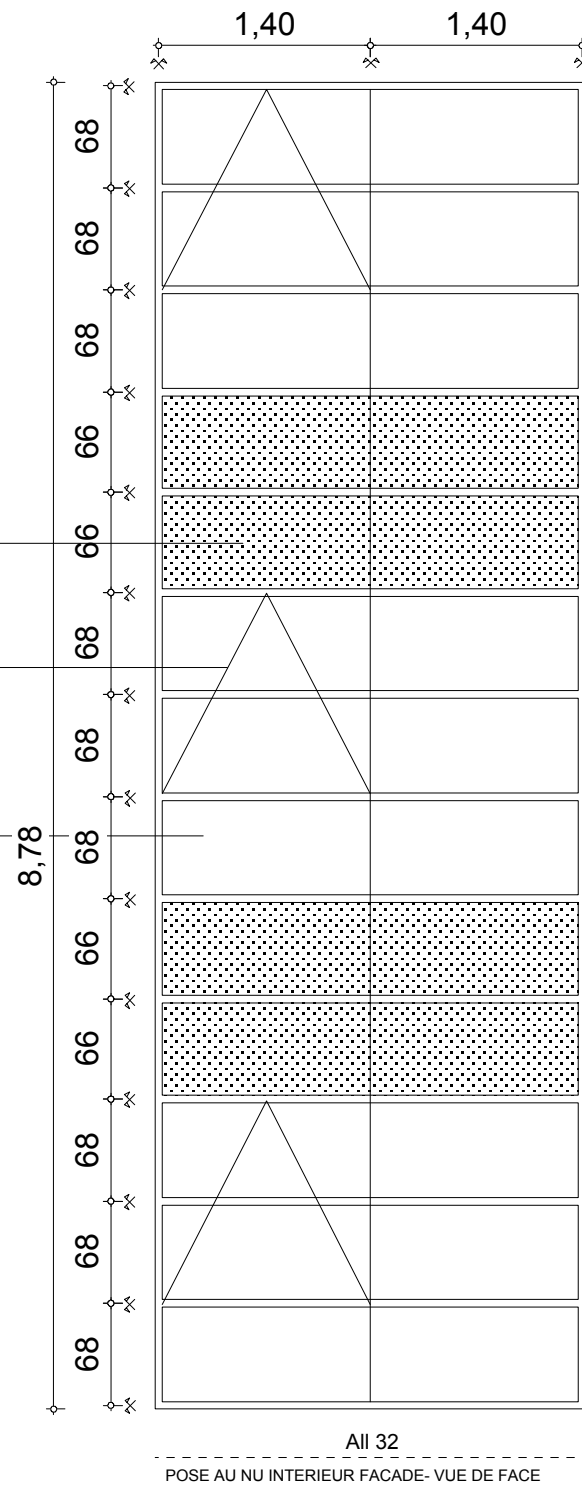

ME04
ENSEMBLE MENUISÉ
AVEC OUVRANTS CACHÉS
+
BRISE SOLEIL BOIS HABILLAGE ALUMINIUM

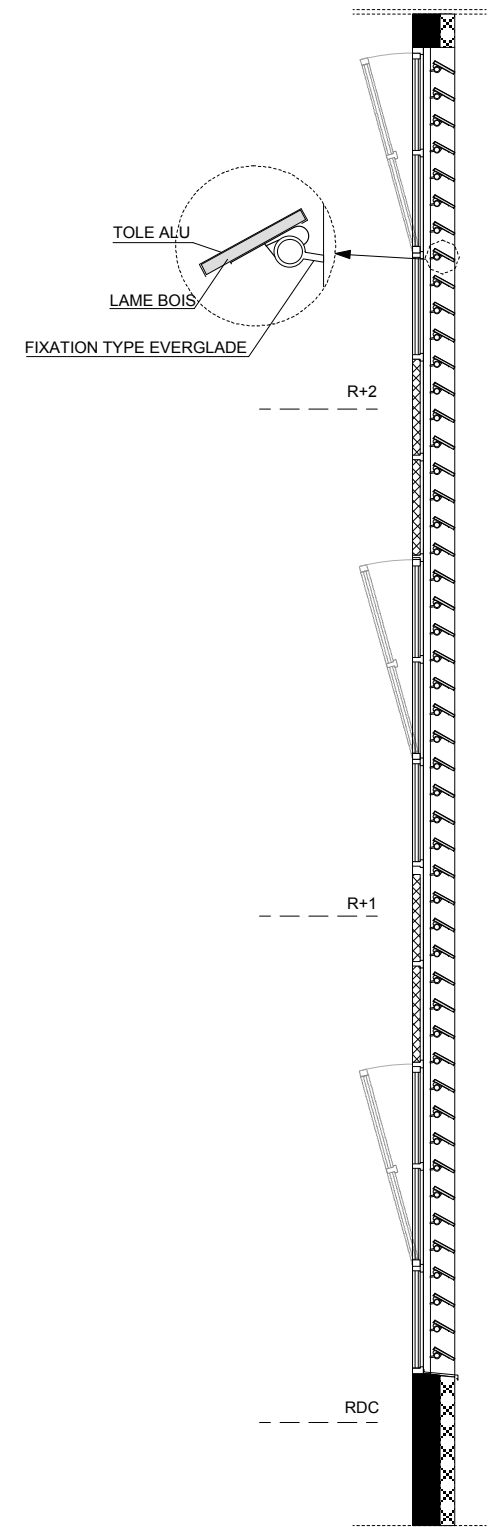
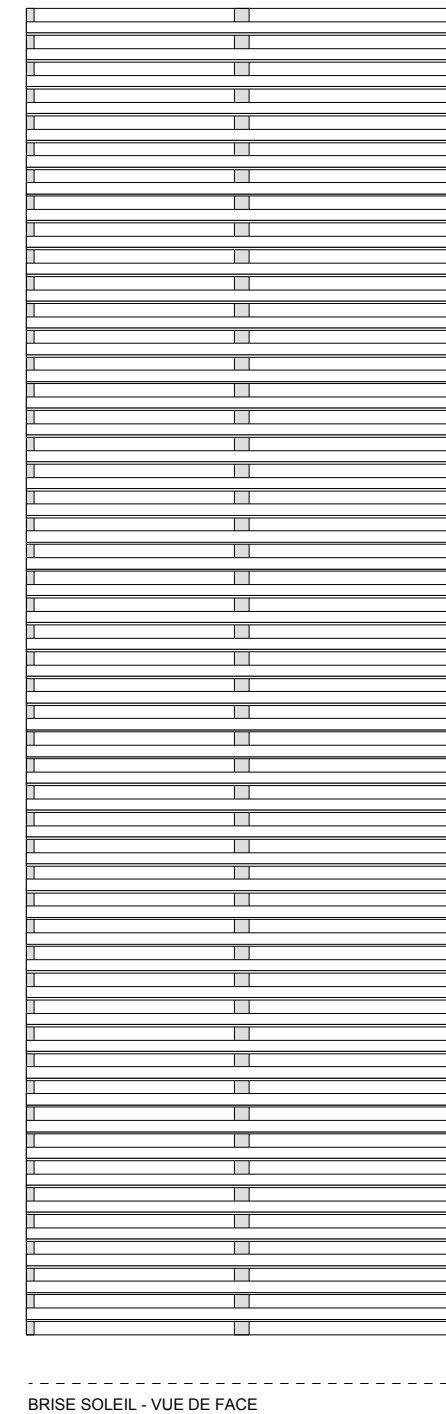

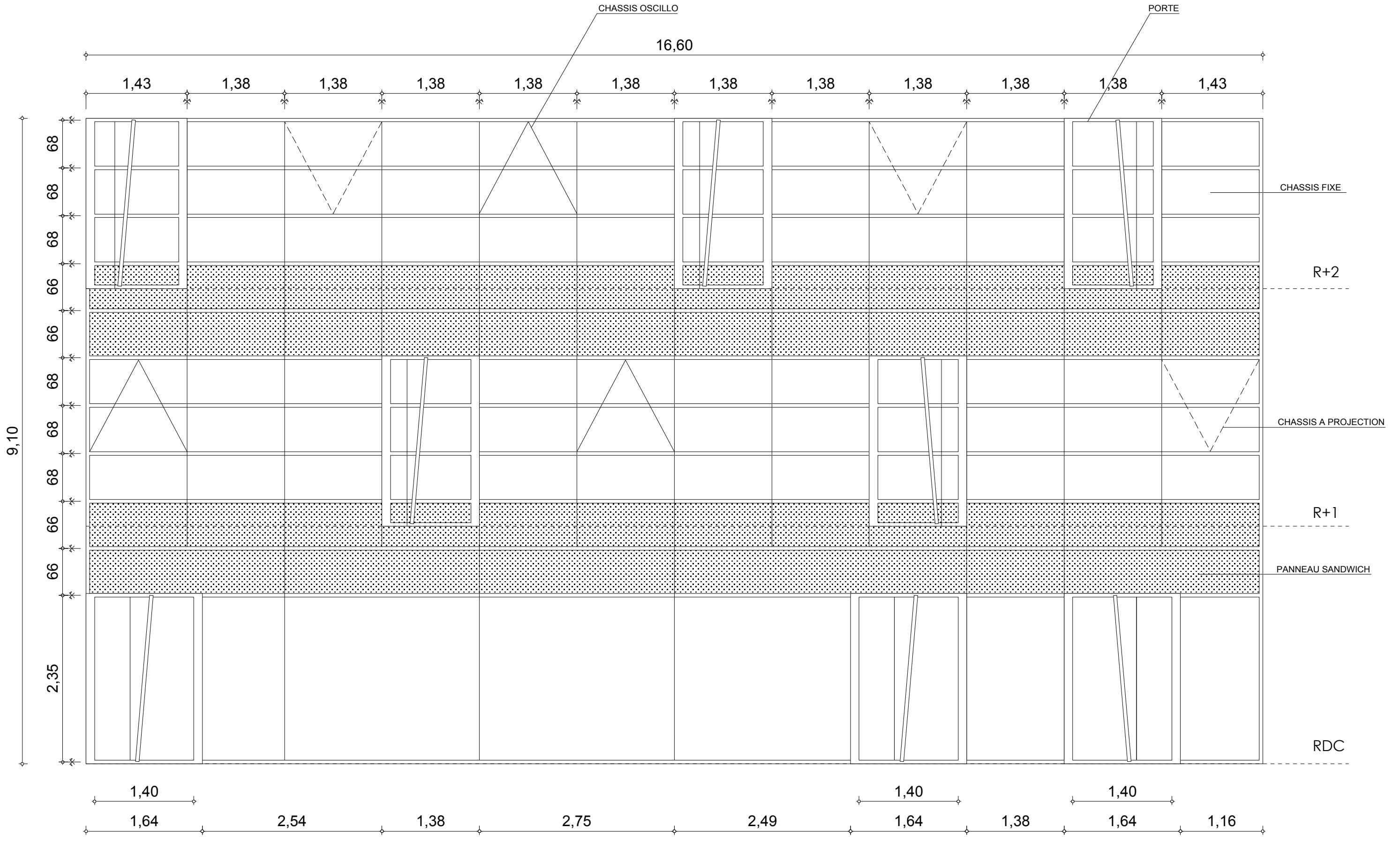

ME05
 ENSEMBLE MENUISÉ
 AVEC OUVRANTS CACHÉS OSCILLO ET A PROJECTION
 +
 PORTES

DETAILS MENUISERIES

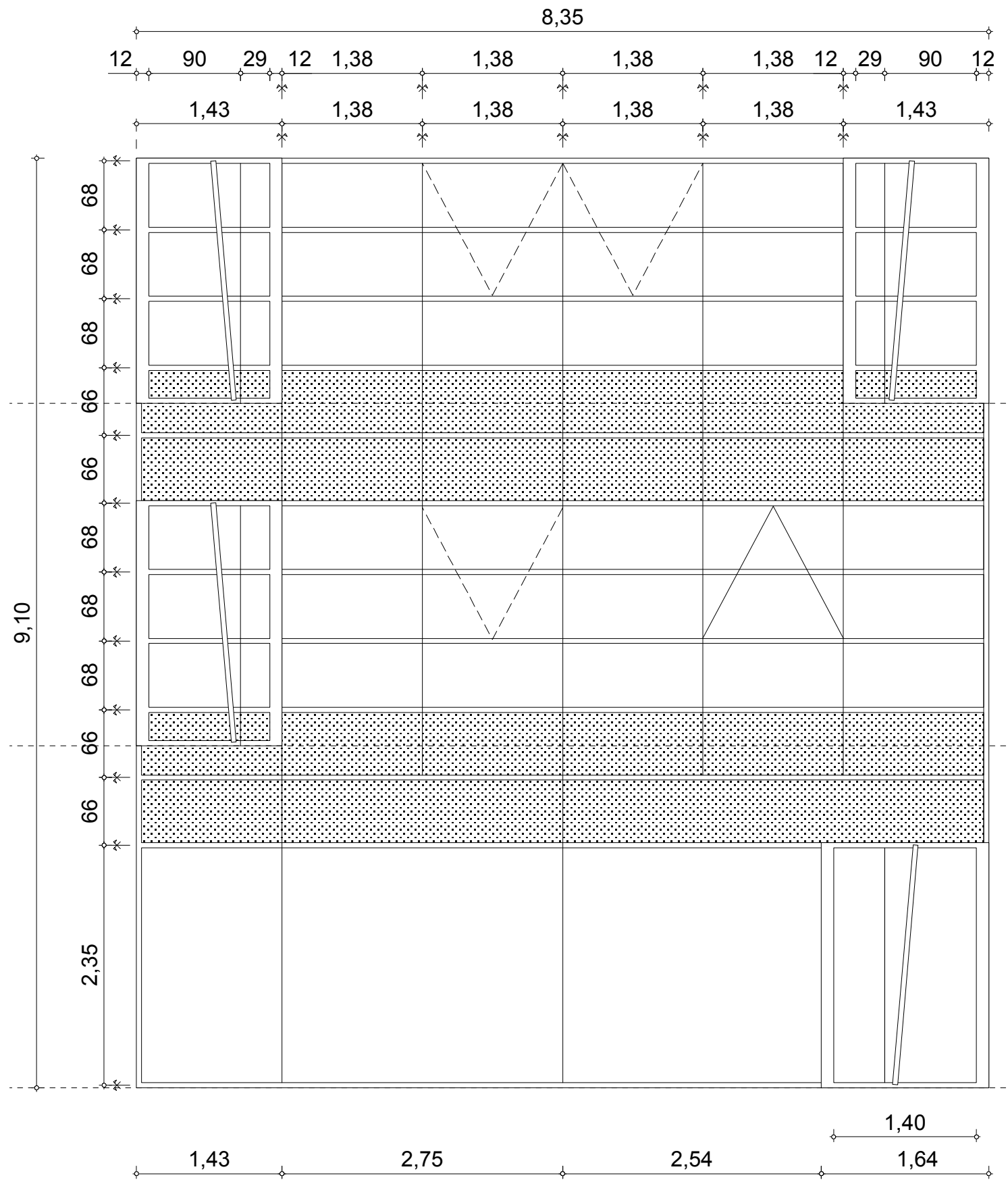

ME06

ENSEMBLE MENUISÉ
 AVEC OUVRANTS CACHÉS OSCILLO ET A PROJECTION
 +
 PORTES

R+2

R+1

RDC

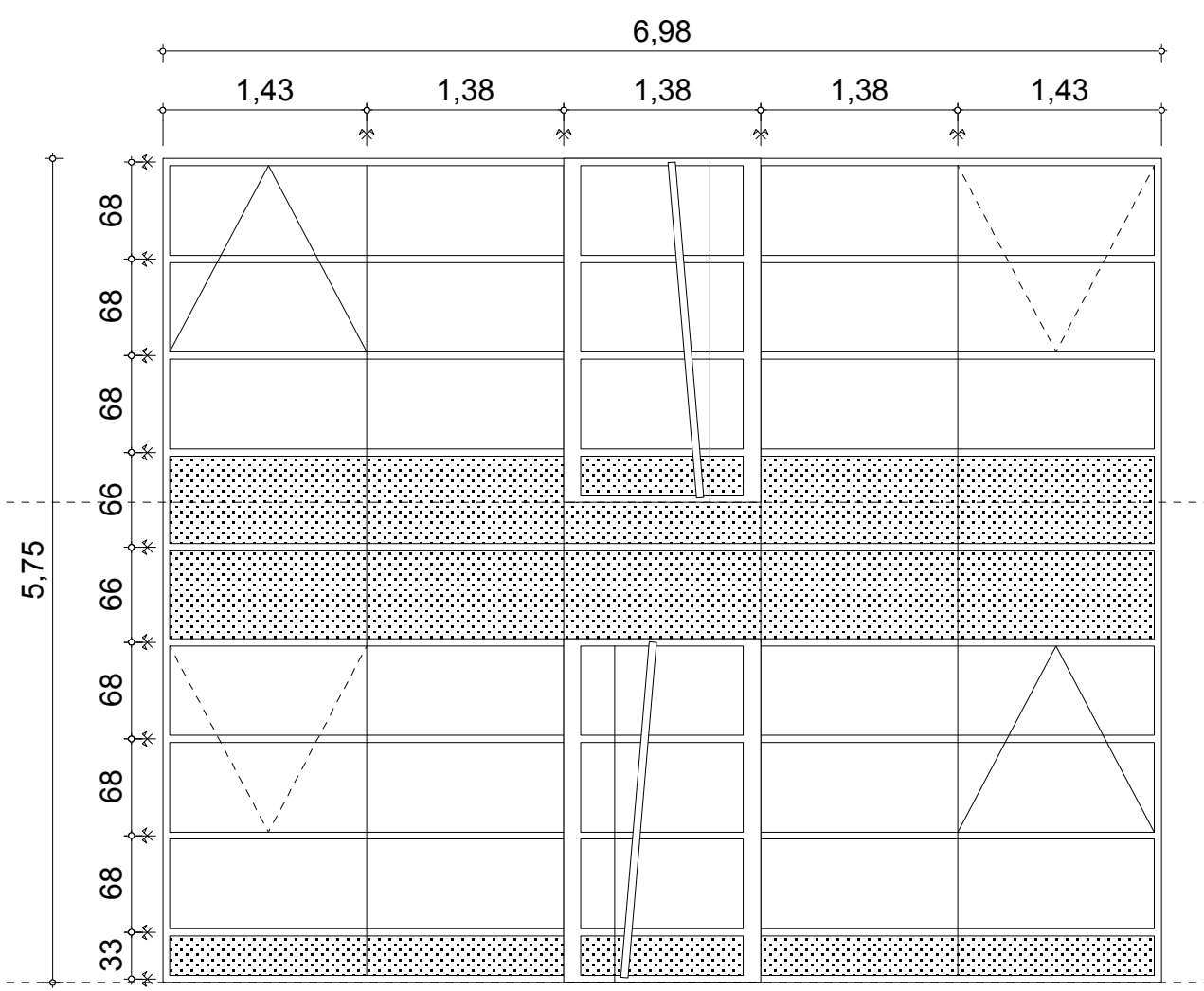

ME07

ENSEMBLE MENUISÉ
 AVEC OUVRANTS CACHÉS OSCILLO ET A PROJECTION
 +
 PORTES

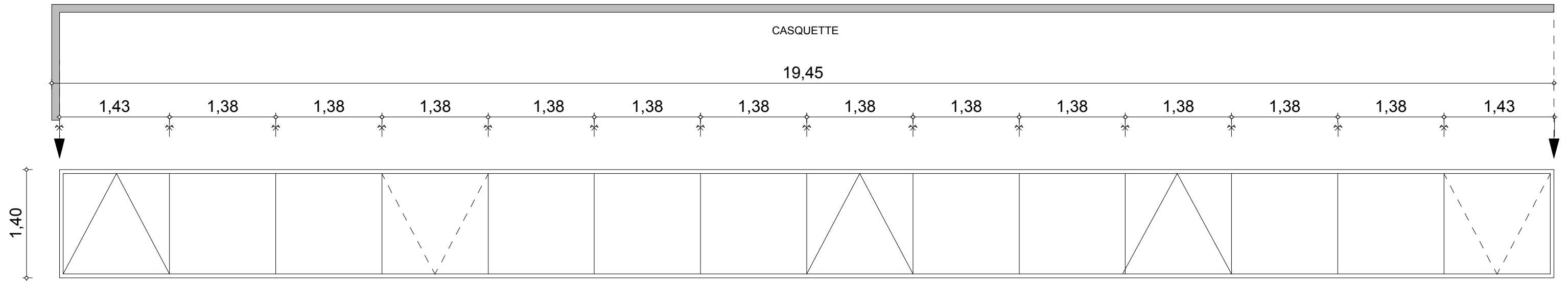

AII 100

ME09

ENSEMBLE MENUISÉ
 AVEC OUVRANTS CACHÉS OSCILLO ET A PROJECTION
 +
 CASQUETTE : TOLE PLIEE ACIER LAQUEE AU FOUR
 SUR OSSATURE INTERIEUR ACIER GALVANISEE

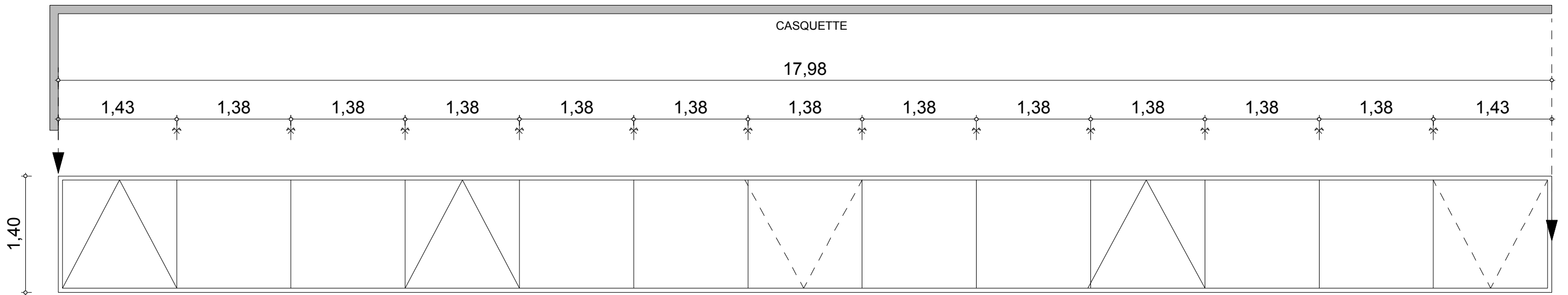

AII 100

ME10

ENSEMBLE MENUISÉ
 AVEC OUVRANTS CACHÉS OSCILLO ET A PROJECTION
 +
 CASQUETTE : TOLE PLIEE ACIER LAQUEE AU FOUR
 SUR OSSATURE INTERIEUR ACIER GALVANISEE

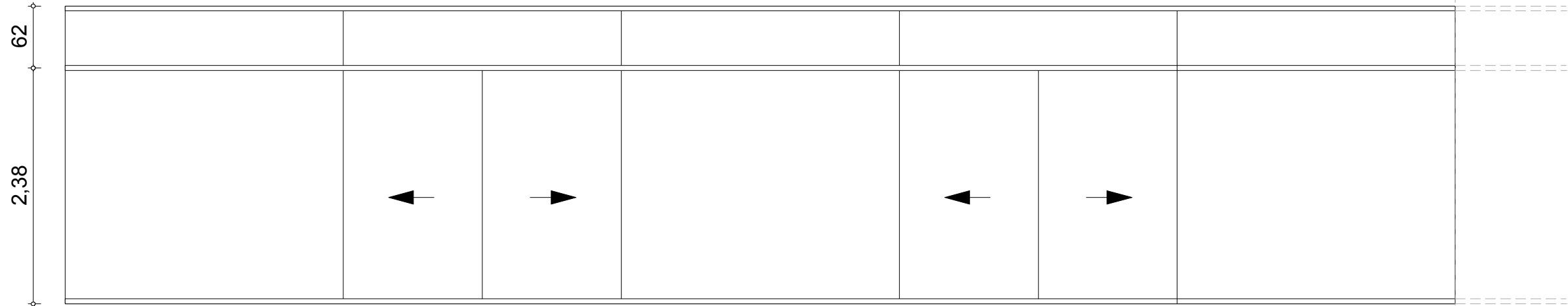
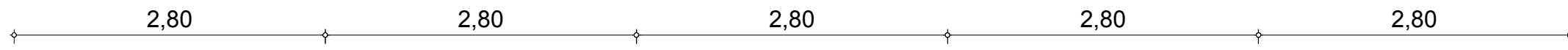
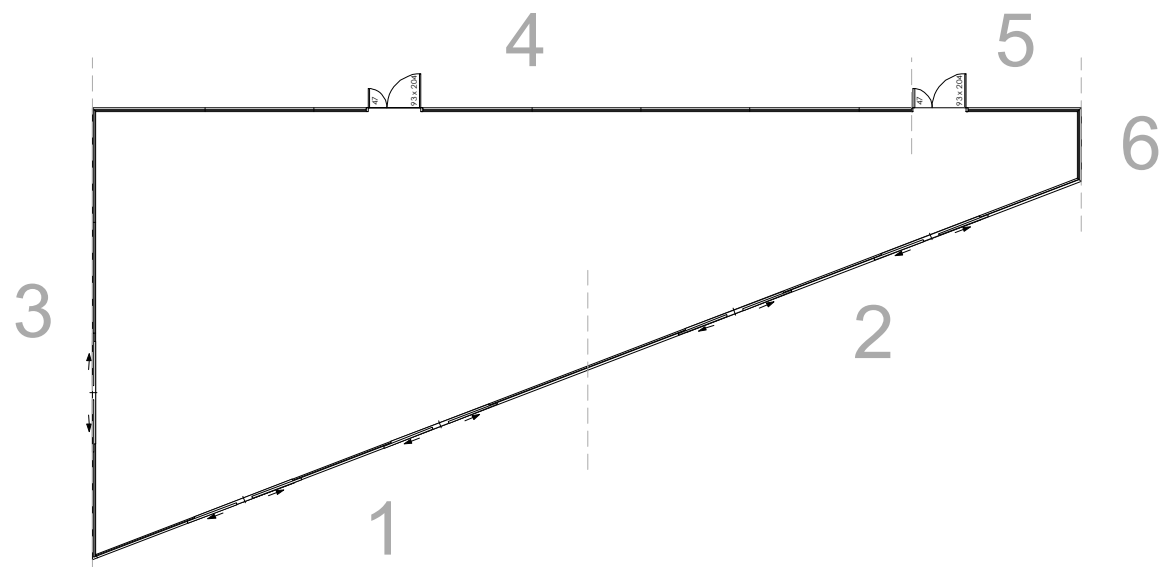

1

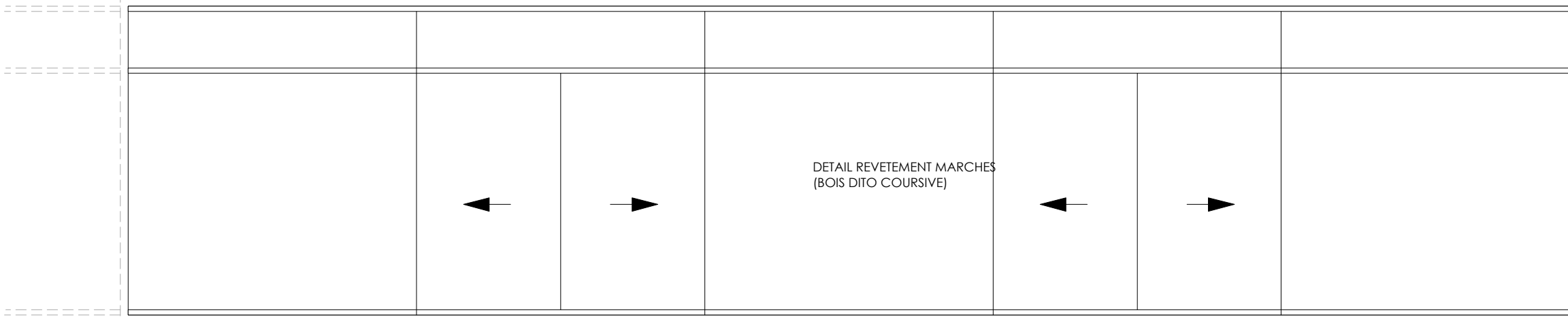
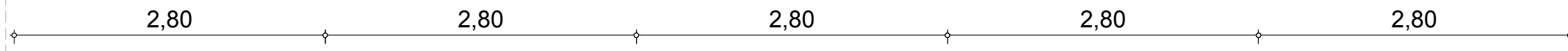

DETAIL REVETEMENT MARCHES
(BOIS DITO COURSIVE)

2

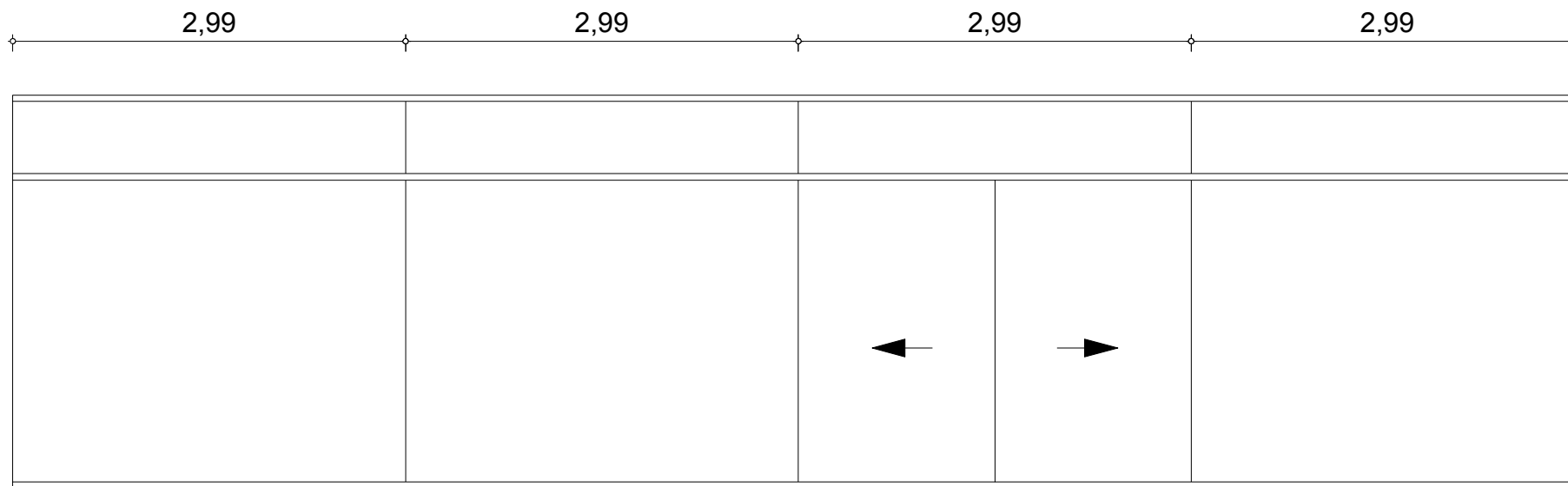

3

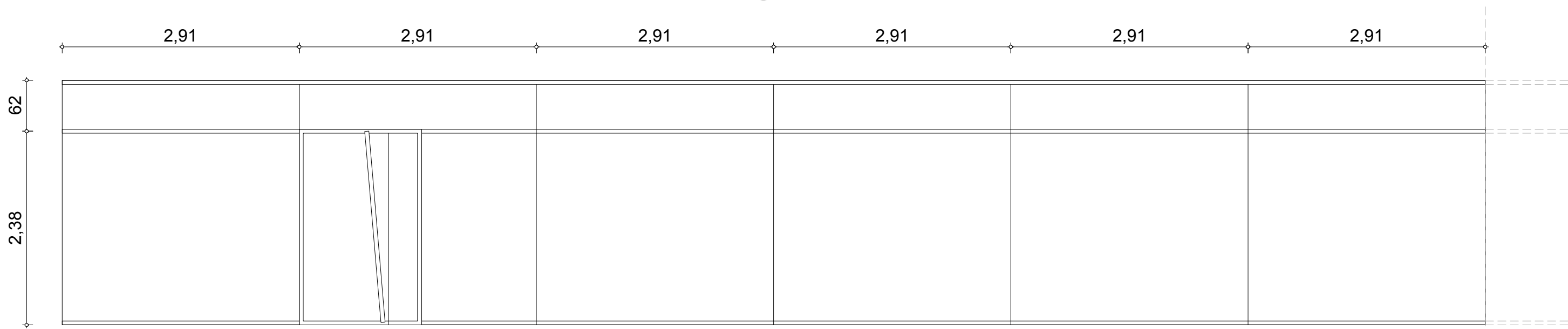

4

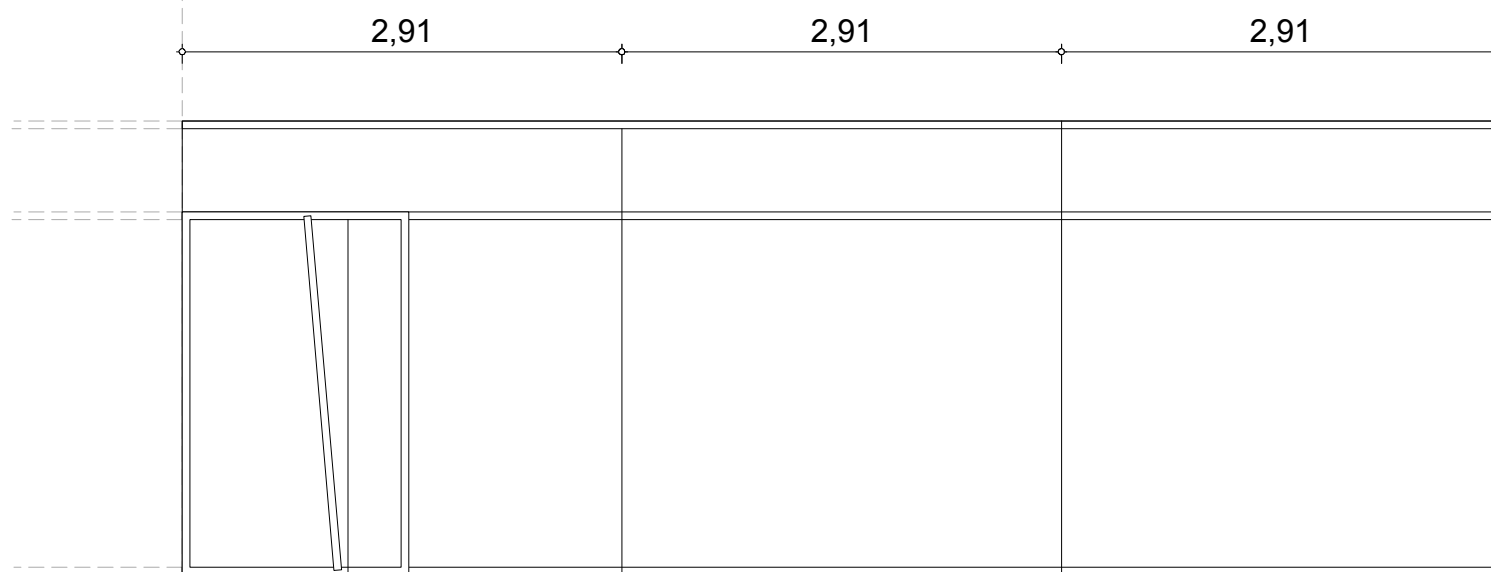

5

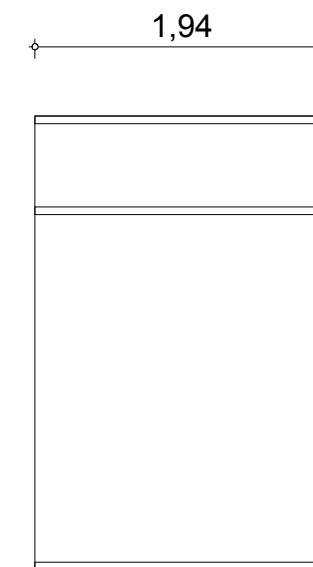

6

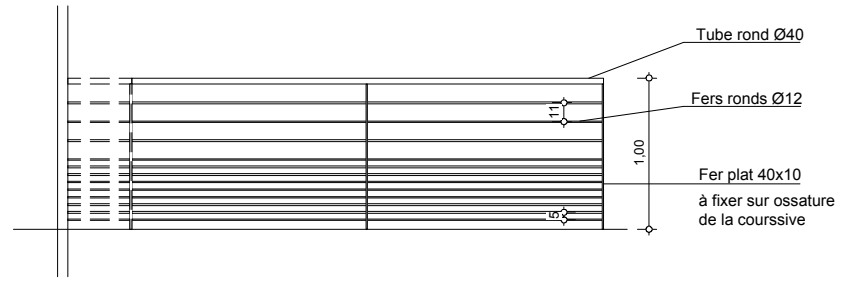
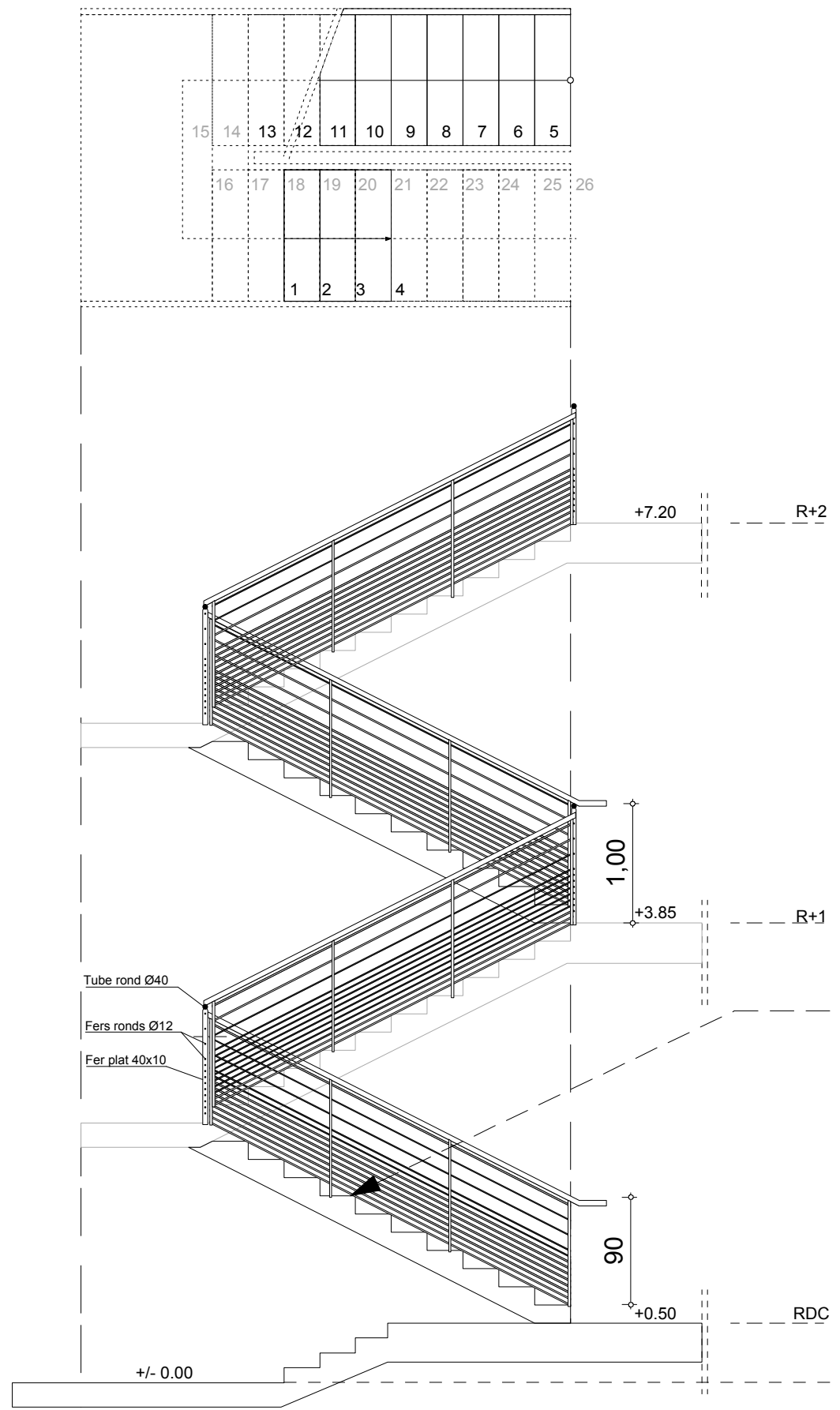

GARDE CORPS

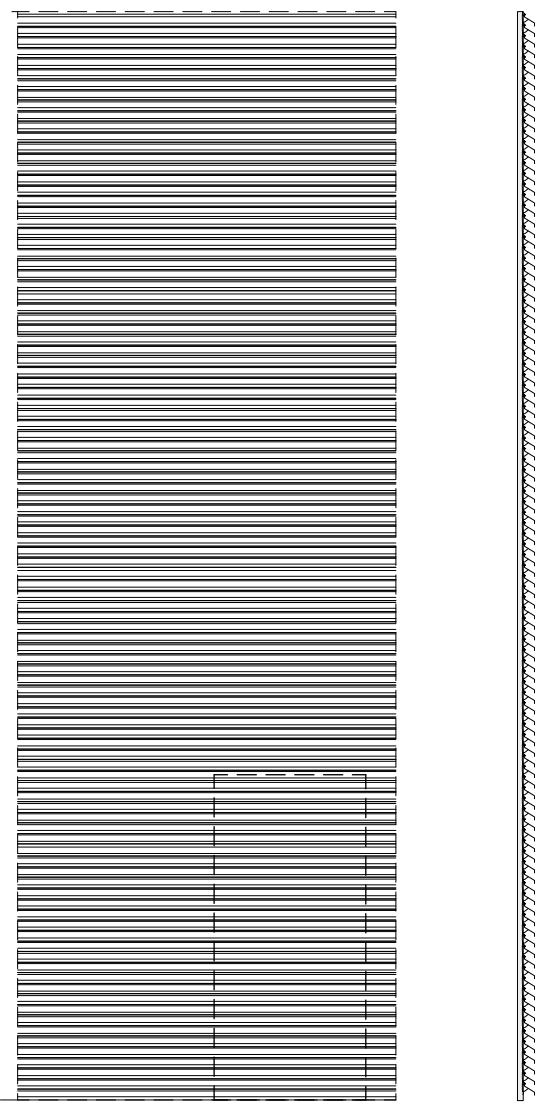
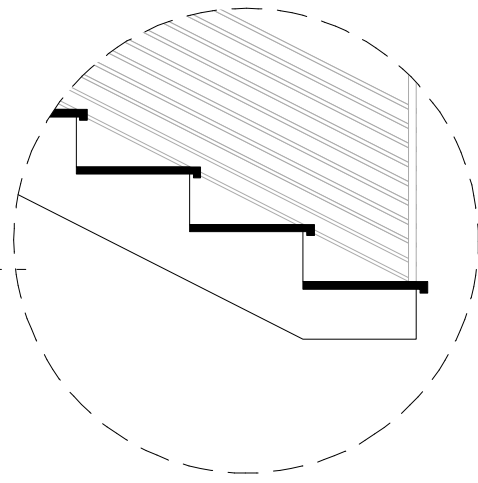

PORTE DE SORTIE DE SECOURS

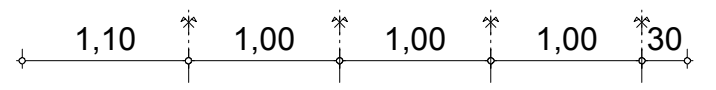

SE01
ESCALIER BETON + MARCHE BOIS IPE

DETAILS SERRURERIE

